

LOFT







I mobili Bridge e Side alcune tra le novità dedicate al contenimento.

_The Bridge and Side furniture ranges are among some of the new products designed for storage.
 _Los muebles Bridge y Side algunas entre las novedades dedicadas a la contención.
 _Les meubles Bridge et Side font partie des nouveautés dédiées au rangement.



Si amplia la gamma di schermi divisorii ed entrano anche pannelli sagomati e fonoassorbenti, disponibili anche in nuovi colori.

_The range of partitions has been expanded to include shaped, sound-absorbing panels, available in new colours too.
 _Se amplía la gama de pantallas divisorias y entran también paneles perfilados y fonoabsorbentes, disponibles también en nuevos colores.
 _La gamme de panneaux de séparation s'agrandit et compte également sur des panneaux façonné et insonorisants, disponibles aussi dans de nouvelles couleurs.



LOFT

Al bianco e all'alluminio si uniscono due nuovi colori per le strutture: grigio Oxford e grigio Londra.

_Two new colours, grigio Oxford and grigio Londra, have been added to the existing white and aluminium for the supports.
 _Al bianco y al aluminio se unen dos nuevos colores para las estructuras: grigio Oxford y grigio Londra.
 _Deux nouvelles couleurs s'ajoutent au blanc et à l'aluminium pour les structures : grigio Oxford et grigio Londra.

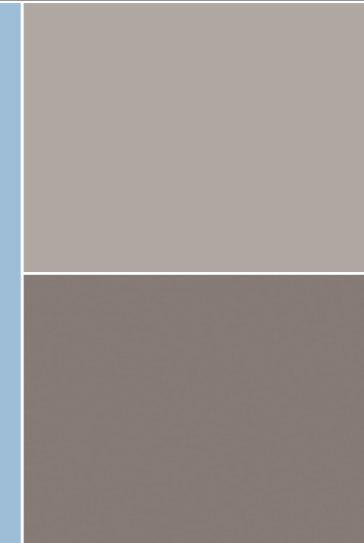

La gamma dei sostegni si completa con il nuovo cavalletto, un'alternativa all'anello chiuso o aperto.

_The range of supports is completed with the new trestle leg, as an alternative to the open or closed U-shape.
 _La gamma de los soportes se completa con el nuevo caballete, una alternativa para el anillo cerrado o abierto.
 _La gamme de supports se complète avec le nouveau tréteau, une alternative au piètement anneau ouvert ou fermé.

LOFT

1/4





Più componibilità, più flessibilità!
Nella collezione Loft ci sono nuove proposte per il contenimento, come il mobile Bridge qui con ante scorrevoli color cedro.
Anche le strutture prevedono delle nuove possibilità di personalizzazione in termini di finitura: qui, ad esempio, troviamo la nuova finitura grigio Oxford.

Increased modularity, more flexibility!
There are some new storage solutions in the Loft Collection, such as the Bridge element shown here with cedar sliding doors.
The structures can also be customised with new finishes, such as the new grigio Oxford finish shown here.

¡Más componibilidad, más flexibilidad!
En la colección Loft hay nuevas propuestas para la contención, como el mueble Bridge aquí con puertas correderas color cedro.
También las estructuras prevén nuevas posibilidades de personalización en términos de acabado: aquí, por ejemplo, encontramos el nuevo acabado grigio Oxford.

Plus de possibilités de composition, plus de flexibilité !
La collection Loft compte sur de nouvelles propositions pour le rangement, comme le meuble Bridge ici avec des portes coulissantes couleur cedro.
Les structures aussi prévoient de nouvelles possibilités de personnalisation en termes de finition : ici par exemple avec la finition grigio Oxford.







Il mobile Bridge è una struttura portante e allo stesso tempo un'ottima soluzione per il contenimento che può essere completamente personalizzata attraverso le finiture e strutturata a piacere scegliendo tra quattro configurazioni differenti.

The Bridge element is a load-bearing structure, but also a great storage solution with fully customisable finishes and a choice of four different configurations to organise however you like.

El mueble Bridge es una estructura portante y al mismo tiempo una óptima solución para la contención que puede ser completamente personalizada a través de los acabados y estructurada a gusto escogiendo entre cuatro configuraciones diferentes.

Le meuble Bridge est une structure porteuse et en même temps une excellente solution pour le rangement, qui peut être entièrement personnalisée à travers les finitions, et structurée à volonté parmi quatre configurations différentes.







La componibilità del sistema Loft consente la progettazione di strutture più ampie e complesse, ma anche la creazione di una semplice postazione singola con porta cpu.

Le casse dei mobili, volendo, possono essere coordinate con le gambe per ottenere un bell'effetto di continuità con la struttura.

The modular design of the Loft system means that, not only can you design bigger, more complex structures, but you can also just set up an individual workstation with a CPU stand.

The inside of the units can also be coordinated with the legs to maintain a pleasant continuity with the whole structure.

La componibilidad del sistema Loft consente el diseño de estructuras más amplias y complejas, pero también la creación de una simple ubicación individual con porta cpu.

Las estructuras de los muebles, si se desea, pueden ser coordinadas con las patas para obtener un gran efecto de continuidad con la estructura.

La possibilité de composition du système Loft permet de concevoir des structures plus grandes et complexes, mais aussi de créer un simple poste individuel avec support pour tour PC.

Les caissons des meubles peuvent, si vous le souhaitez, être assortis aux piètements pour obtenir un bel effet de continuité avec la structure.







La gamba ad anello aperto è disponibile anche con meccanismo di regolazione in altezza: una soluzione pratica sia per rialzare la singola scrivania sia per creare composizioni con piani di lavoro modulati.

The open ring leg is also available with a height adjustment mechanism. A practical solution for raising the height of just one desk to create compositions with modular work tops.

La pata de anillo abierto está también disponible con mecanismo de regulación de altura: una solución práctica para realzar el escritorio individual y crear composiciones con encimeras de trabajo moduladas.

Le piètement anneau ouvert est également disponible avec un mécanisme de réglage en hauteur: une solution pratique aussi bien pour rehausser le bureau que pour créer des compositions avec des plans de travail modulés.



LOFT

5/8









Le scrivanie possono essere accessoriate con modesty panel sagomati o lineari e con schermi divisorii coordinati. La modularità degli accessori è uno dei must di Loft!

The desks can be fitted with shaped or straight modesty panels and coordinated partition screens. Modular accessories are a must for the Loft Collection!

Los escritorios pueden llevar accesorios con modesty panel perfilados o lineales y con pantallas divisorias coordinadas. ¡La modularidad de los accesorios es uno de los must de Loft!

Les bureaux peuvent être accessorisés avec des modesty panel profilés ou linéaires et avec des panneaux de séparation coordonnés. La modularité des accessoires est un must de Loft !

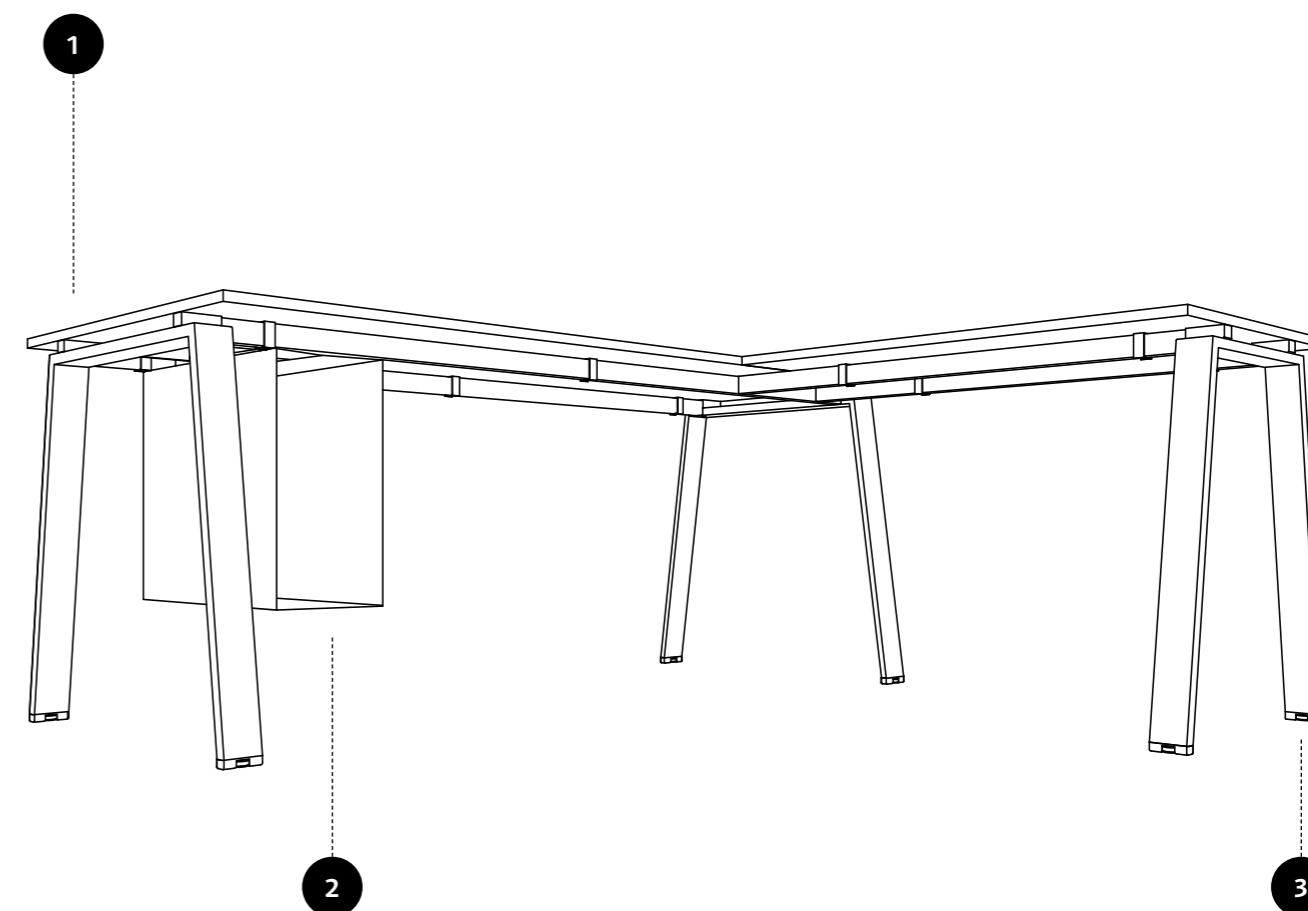

1 I piani scrivania sono disponibili in 7 finiture melaminico e in 5 colori di vetro.

2 Il porta cpu sospeso è una soluzione salvaspazio perfettamente integrata alla struttura.

3 Il sostegno a cavalletto è una delle novità della linea Loft.

1 The desk tops are available in 7 different melamine finishes and in 5 glass colours.

2 The under-desk CPU holder is a space-saving solution that fits in perfectly with the structure.

3 The trestle leg is one of the new features in the Loft range.

1 Las encimeras de escritorio están disponibles en 7 acabados melamínico y en 5 colores de cristal.

2 El porta cpu suspendido es una solución salvaspacio perfectamente integrada a la estructura.

3 El soporte a caballete es una de las novedades de la línea Loft.

1 Les plans de bureau sont disponibles en 7 finitions mélaminées et en 5 couleurs de verre.

2 Le support suspendu pour tour PC est une solution gain de place parfaitement intégrée à la structure.

3 Le support en tréteau est l'une des nouveautés de la ligne Loft.

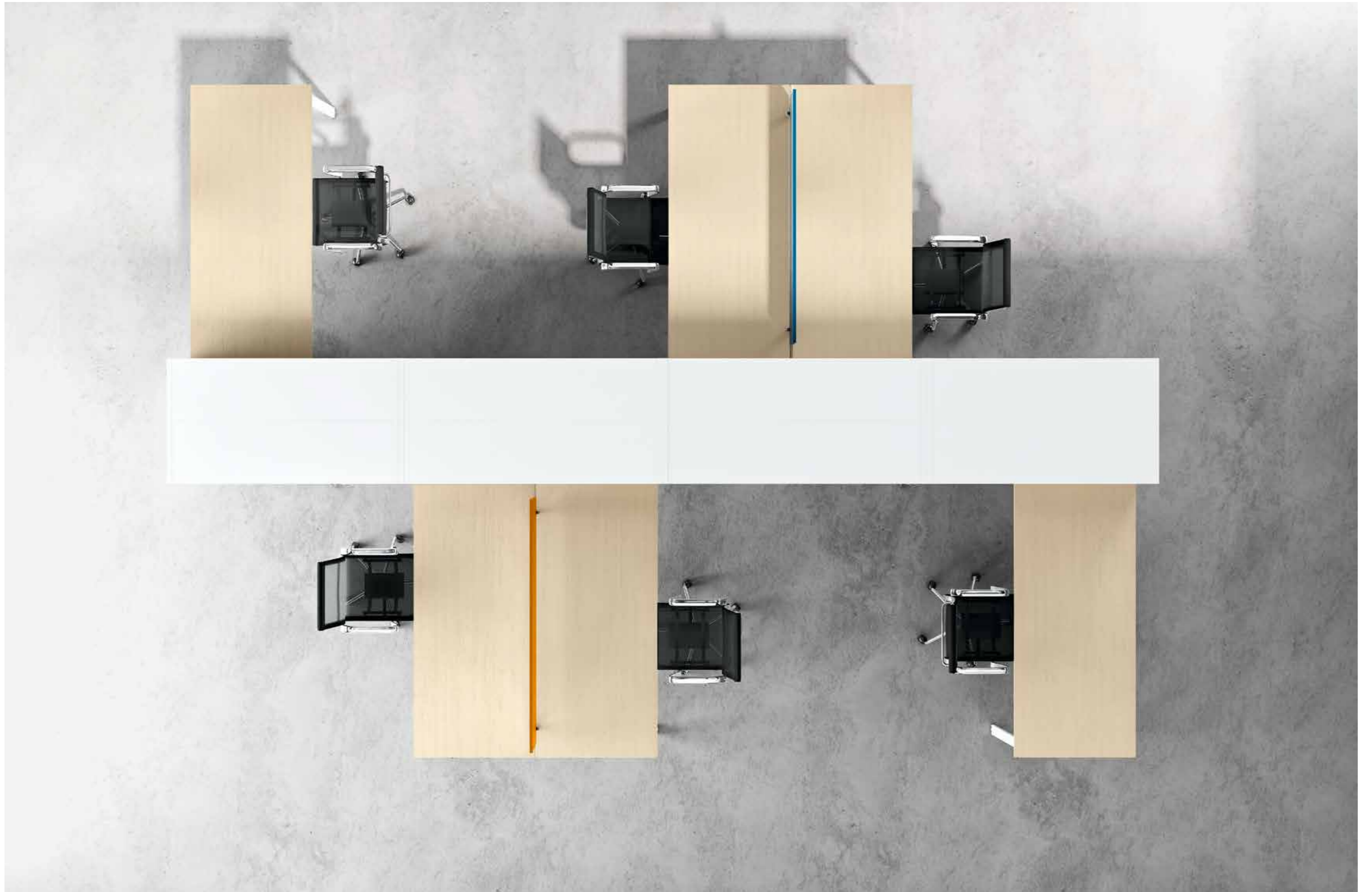





Le ante del mobile Bridge sono disponibili in ben 17 finiture: una palette di colori molto contemporanea è stata affiancata alle essenze più classiche.

The doors of the Bridge element are available in no less than 17 finishes: a palette of truly contemporary colours has been added to the classic shades.

Las puertas del mueble Bridge están disponibles en 17 acabados: una paleta de colores muy contemporánea ha sido puesta a disposición de las esencias más clásicas.

Les portes du meuble Bridge sont disponibles en 17 finitions : une palette de couleurs très contemporaine a été associée aux exigences les plus classiques.

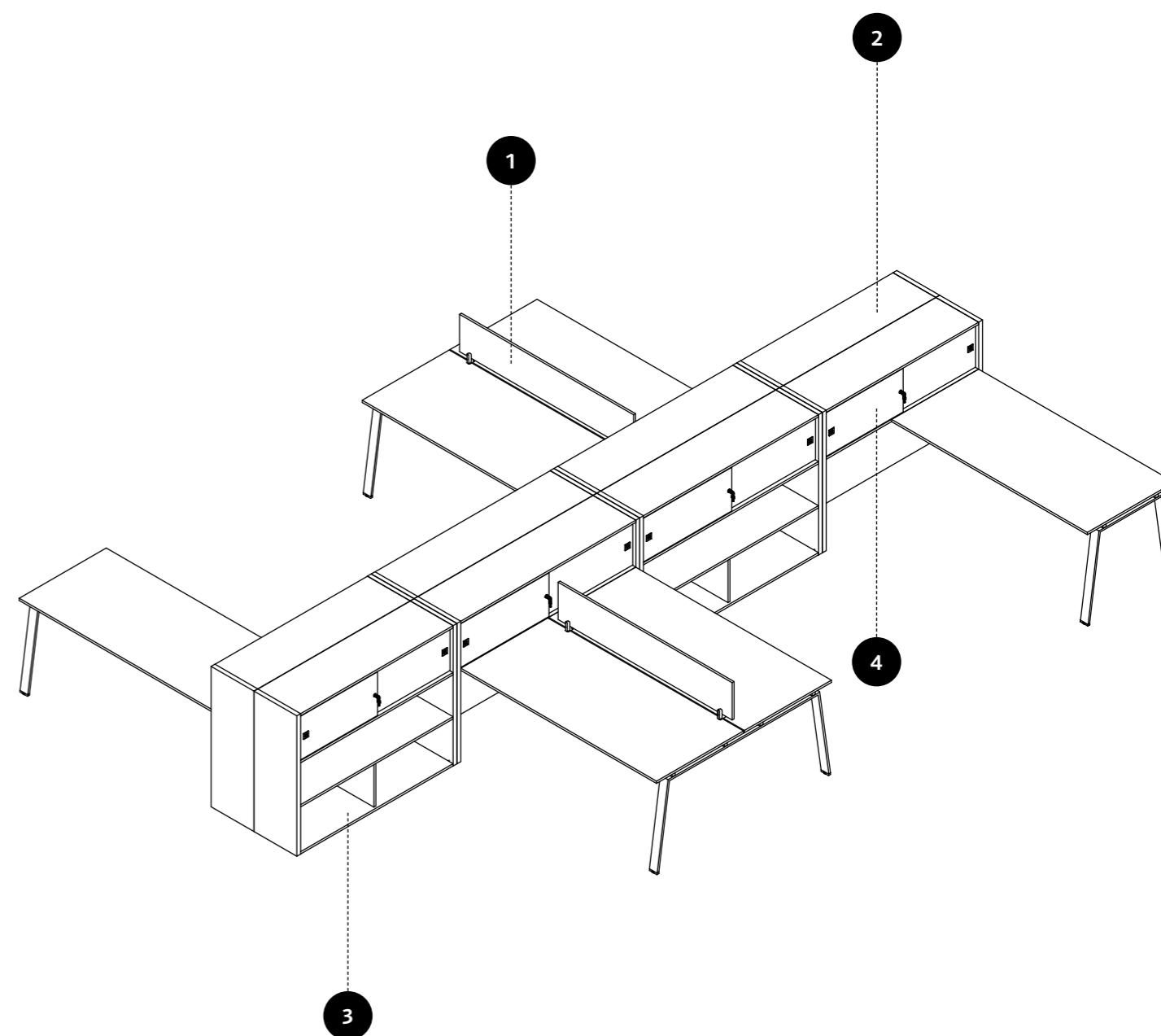

1 Gli schermi divisorii lineari sono disponibili in 8 differenti lunghezze e 17 finiture.

2 Le configurazioni del mobile Bridge sono 4 e possono essere combinate tra loro in base alle esigenze.

3 Le casse del mobile Bridge sono disponibili nelle finiture dei piani scrivania.

4 Le ante scorrevoli sono disponibili in 17 finiture e possono essere coordinate con gli altri elementi della struttura.

1 The straight partition panels are available in 8 different lengths and 17 finishes.

2 There are four Bridge configurations which can be linked based on your requirements.

3 The inside of the Bridge element is available in the same finish as the desk tops.

4 The sliding doors are available in 17 finishes which can be coordinated with the other elements of the structure.

1 Las pantallas divisorias lineales están disponibles en 8 diferentes largos y 17 acabados.

2 Las configuraciones del mueble Bridge son 4 y pueden ser combinadas entre ellas en base a las exigencias.

3 Las estructuras del mueble Bridge están disponibles en los acabados de las encimeras de escritorio.

4 Las puertas correderas están disponibles en 17 acabados y pueden ser coordinadas con los otros elementos de la estructura.

1 Les panneaux de séparation linéaires sont disponibles en 8 longueurs et 17 finitions différentes.

2 Les configurations du meuble Bridge sont au nombre de 4 et peuvent être associées les unes aux autres en fonction des besoins.

3 Les caissons du meuble Bridge sont disponibles avec les mêmes finitions que les plans de bureau.

4 Les portes coulissantes sont disponibles en 17 finitions et peuvent être coordonnées aux autres éléments de la structure.



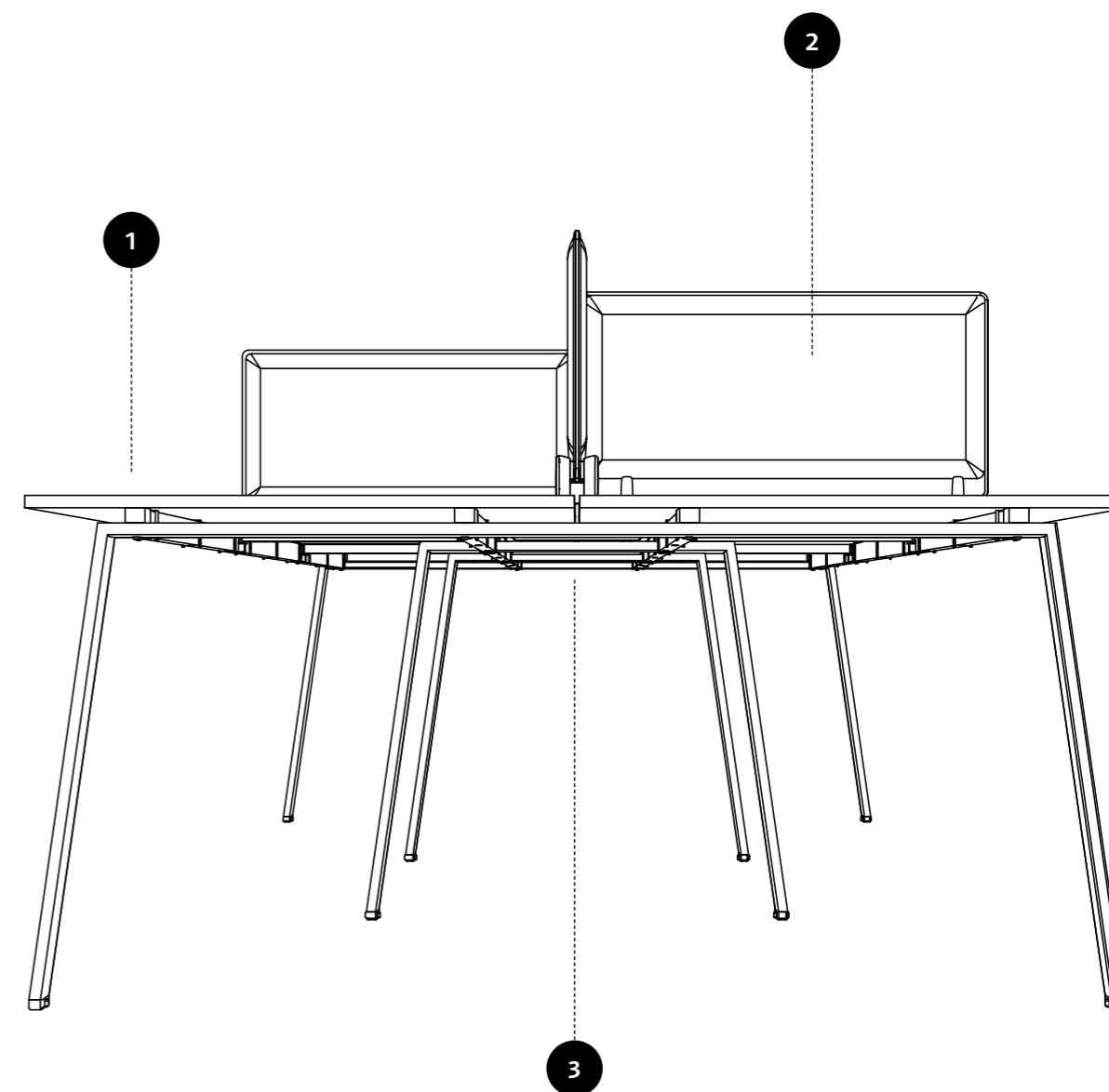

❶ I piani scrivania in melaminico sono disponibili in due diversi spessori: 18 mm o 25 mm.

❷ Gli schermi fonoassorbenti, frontali e laterali, consentono la creazione di aree di lavoro più riservate.

❸ Il nuovo sostegno centrale è rientrante e agevola il movimento a favore dell'ergonomia.

❶ The melamina desk tops are available in two different thickness: 18 mm or 25 mm.

❷ The front and side sound-absorbing panels allow more private work spaces to be created.

❸ The new central support is recessed to make movement easier and more ergonomic.

❶ Las encimeras de melamina de escritorio están disponibles en dos espesores diferentes: 18 mm o 25 mm.

❷ Las pantallas fonoabsorbentes, frontales y laterales, permiten la creación de áreas de trabajo más reservadas.

❸ El nuevo soporte central es retráctil y facilita el movimiento a favor de la ergonomía.

❶ Les plans pour bureau en mélamine sont disponibles en deux épaisseurs différentes : 18 mm ou 25 mm.

❷ Les panneaux insonorisants, avant et latéraux, permettent de créer des espaces de travail plus réservés.

❸ Le nouveau support central est escamotable et simplifie le mouvement en faveur de l'ergonomie.

LOFT

9/12





Ecco come due postazioni singole possono essere declinate in modo differente attraverso le finiture. Nella proposta principale il piano e l'anta del mobile Swing sono in rovere grigio e abbinati alla gamba in grigio Londra; per la variante è stato scelto un piano in vetro Oxford abbinato al total white del mobile Swing e della gamba.

An example of how two individual workstations can be interpreted with different finishes. In the main solution, the desk top and Swing unit door are in rovere grigio matching the leg in grigio Londra whereas for the variation, a desk top in Oxford glass has been chosen to match the total white Swing unit and desk leg.

Es así como dos ubicaciones individuales pueden ser declinadas de modo diferente a través de los acabados. En la propuesta principal la encimera y la puerta del mueble Swing son en rovere grigio y combinadas a la pata en grigio Londra; para la variante ha sido escogida una encimera en cristal Oxford combinada al total white del mueble Swing y de la pata.

Voici comment deux postes individuels peuvent être déclinés de manière différente grâce aux finitions. Dans la proposition principale, le plan et la porte du meuble Swing sont en rovere grigio et assortis au piètement grigio Londra ; pour la variante, un plan en verre Oxford a été choisi, assorti au total white du meuble Swing et du piètement.



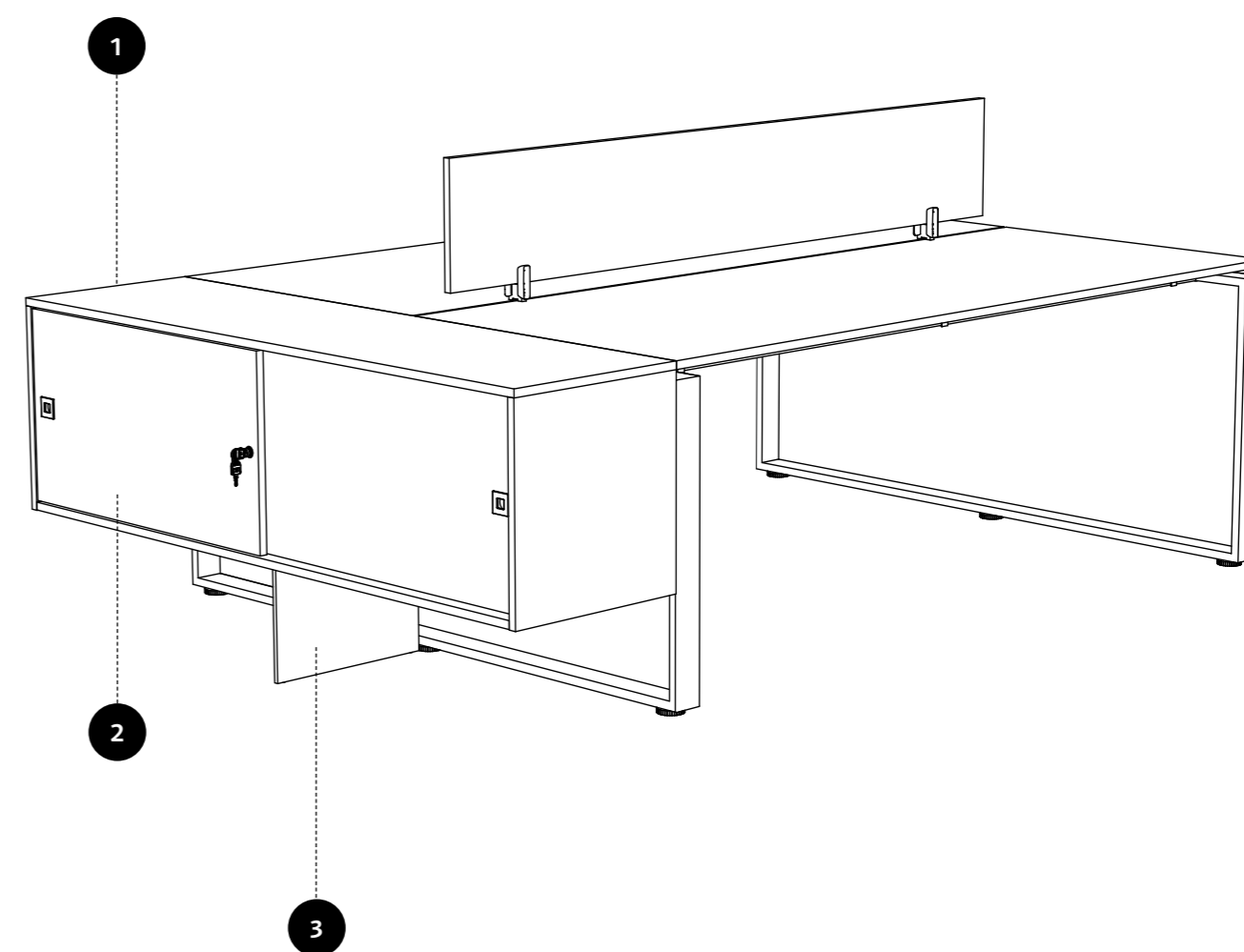

1 Il mobile Side è un elemento di forte impatto estetico e grande praticità può essere abbinato alla scrivania scegliendo la continuità o una soluzione bicolor.

2 Le ante scorrevoli, come quelle del mobile Bridge, sono disponibili in 17 diverse finiture.

3 Il sostegno in plexiglass similvetro è di spessore 10 mm.

1 The Side unit creates a strong visual impact and is very practical. It can be matched to the desk by opting for the same colour or a two-tone solution.

2 The sliding doors, like the ones for the Bridge element, are available in 17 different finishes.

3 The plexiglass support is 10 mm thick.

1 El mueble Side es un elemento de fuerte impacto estético y gran practicidad puede ser combinado al escritorio escogiendo la continuidad o una solución bicolor.

2 Las puertas corredizas, como las del mueble Bridge, están disponibles en 17 acabados diferentes.

3 El soporte en plexiglas símil cristal es de 10 mm de espesor

1 Le meuble Side est un élément au fort impact esthétique et d'une grande commodité qui peut être assorti au bureau, en choisissant la continuité ou une solution bicolor.

2 Les portes coulissantes, comme celles du meuble Bridge, sont disponibles en 17 finitions différentes.

3 Le support en plexiglass effet verre a une épaisseur de 10 mm.





La finitura olmo storm qui è stata abbinata alla gamba color alluminio e agli schermi fonoassorbenti in canapa.

The Olmo Storm finish shown here has been matched with an aluminium leg and sound-absorbing partitions in Canapa.

El acabado olmo storm aquí ha sido combinado a la pata color aluminio y a las pantallas fonoabsorbentes en canapa.

La finition olmo storm a été associée ici au piètement couleur aluminium et aux panneaux insonorisants en canapa.





L'introduzione degli schermi divisorii fonoassorbenti impreziosisce la gamma di accessori Loft e introduce un'importante elemento per l'ottimizzazione dell'ambiente di lavoro. Anche dal punto di vista estetico, grazie ai colori disponibili, consentono maggior creatività nell'arredare.

The introduction of sound-absorbing partitions lends an elegant touch to the range of Loft accessories and introduces an important element for optimising the work environment. From an aesthetic point of view, the colours available allow for greater interior design creativity.

La introducción de las pantallas divisorias fonoabsorbentes embellece la gama de accesorios Loft e introduce un importante elemento para la optimización del ambiente de trabajo. Incluso desde el punto de vista estético, gracias a los colores disponibles, permiten mayor creatividad al amueblar.

L'introduction des panneaux de séparation insonorisants enrichit la gamme d'accessoires Loft et offre un élément important pour l'optimisation de l'espace de travail. Grâce aux couleurs disponibles, ils offrent une plus grande créativité d'un point de vue esthétique.

LOFT

13







La collezione prevede anche una gamma di tavoli riunione fissi o componibili. Le strutture possono essere create con tutti i tipi di sostegno e integrate con gamba centrale elettrificabile e carter ispezionabile.

The collection also includes a range of fixed or linkable meeting tables. The structures can be created with all the different supports and the addition of a central leg with electrical connections and inspection covers.

La colección prevé también una gama de mesas de reunión fijas o componibles. Las estructuras pueden ser creadas con todos los tipos de soporte e integradas con pata central que se puede electrificar y cárter que se puede inspeccionar.

La collection prévoit aussi une gamme de tables de réunion fixes ou composables. Les structures peuvent être créées avec tous les types de support et intégrées avec un piètement central pouvant être électrifié et des carter pouvant être inspectés.



INFORMAZIONI TECNICHE

Technical information

Datos técnicos

Renseignements techniques

LOFT - SCRIVANIE PIANI IN MELAMINICO

LOFT - Melamine desks tops / LOFT - Escritorios con tablero de melamina / LOFT - Bureaux plan en melamine

Scrivania

Desk / Escritorio / Bureau



L	P	H
80	60	75 - 75,7
100		
120		
140		
160		
180		
200		
L	P	H
80	80	75 - 75,7
100		
120		
140		
160		
180		
200		

Scrivania

Desk / Escritorio / Bureau



L	P	H
200	100	75 - 75,7

Scrivania collegabile

Modular desk / Escritorio que se puede unir / Élément de Bureau



L	P	H
80	60	75 - 75,7
100		
120		

Scrivania per cassetiera base

Desk with basic drawer unit / Escritorio para cajonera base / Bureau pour caisson à tiroirs de base



L	P	H
160	60	75 - 75,7
180		
200		
200		
L	P	H
160	80	75 - 75,7
180		
200		
200		

Scrivania per mobile di servizio, porta CPU e Swing

Desk with support element, CPU holder and Swing / Escritorio para mueble de servicio, porta CPU y Swing / Bureau pour meuble de service, support pour tour PC et Swing



L	P	H
160	60	75 - 75,7
180		
200		
L	P	H
160	80	75 - 75,7
180		
200		

Scrivania per mobile di servizio, porta CPU e Swing

Desk with support element, CPU holder and Swing / Escritorio para mueble de servicio, porta CPU y Swing / Bureau pour meuble de service, support pour tour PC et Swing



L	P	H
200	100	75 - 75,7

Piani

Tops / Tableros / Plans



BIANCO OPACO
B17A



GRIGIO DORIAN
GL4R



ACERO
AC2J



OLMO
LM7P



OLMO STORM
OS3Q



ROVERE PORTOFINO
RP5T



ROVERE GRIGIO
RG9D

Sostegni

Support elements / Estructuras de soporte / Supports



ALLUMINIO
AL5Z
(RAL 9006)

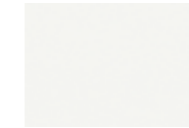

BIANCO OPACO
B17A
(RAL 9003)



GRIGIO OXFORD
G05T



GRIGIO LONDRA
GL7H

LOFT - SCRIVANIE PIANI IN MELAMINICO

LOFT - Melamine desks tops / LOFT - Escritorios con tablero de melamina / LOFT - Bureaux plan en melamine

Scrivanìa Multipla (2 Scrivanie)

Multiple desk (2 desks) / Escritorio Multiple (2 Escritorios) / Bureau Multiple (2 Bureaux)



L	P	H
160	80	75 - 75,7
200		
240		
280		
320		
360		
400		

Scrivanìa Multipla (3 Scrivanie)

Multiple desk (3 desks) / Escritorio Multiple (3 Escritorios) / Bureau Multiple (3 Bureaux)



L	P	H
240	80	75 - 75,7
300		
360		
420		
480		
540		
600		

Workstation

Workstation / Estación de trabajo / Station de travail



L	P	H
160	160	75 - 75,7

Scrivanìa collegabile a workstation

Desk to link to a workstation / Escritorio que se puede unir a estación de trabajo / Bureau raccordable à station de travail



L	P	H
80	60	75 - 75,7
100		
120		
140		
160		
180		
200		
L	P	H
80	80	75 - 75,7
100		
120		
140		
160		
180		
200		

Workstation per cassettera base

Workstation for basic drawer unit / Estación de trabajo para cajonera base / Station de travail pour caisson à tiroirs de base



L	P	H
160	160	75 - 75,7

Bench

Bench desk / Banco / Banc



L	P	H
80	160,8	75 - 75,7
100		
120		
140		
160		
180		
200		

Bench per cassettera base

Bench desk for basic drawer unit / Banco para cajonera base / Banc pour caisson à tiroirs de base



L	P	H
160	160,8	75 - 75,7
180		
200		

Bench per mobile di servizio

Bench desk for support unit / Banco para mueble de servicio / Banc pour meuble de service



L	P	H
160	160,8	75 - 75,7
180		
200		

Piani

Tops / Tableros / Plans

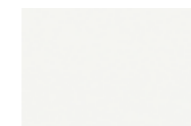

BIANCO OPACO
B17A



GRIGIO DORIAN
GL4R



ACERO
AC2J



OLMO
LM7P



OLMO STORM
OS3Q



ROVERE PORTOFINO
RP5T



ROVERE GRIGIO
RG9D

Sostegni

Support elements / Estructuras de soporte / Supports

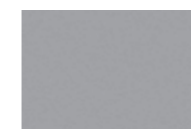

ALLUMINIO
AL5Z
(RAL 9006)

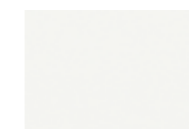

BIANCO OPACO
B17A
(RAL 9003)



GRIGIO OXFORD
GOST



GRIGIO LONDRA
GL7H

LOFT - SCRIVANIE PIANI IN MELAMINICO

LOFT - Melamine desks tops / LOFT - Escritorios con tablero de melamina / LOFT - Bureaux plan en melamine

Bench Multiplo (2 bench)

Multiple Bench desk (2 bench desks) / Banco Multiple (2 banco) / Banc Multiple (2 bancs)



L	P	H
160	160,8	75 - 75,7
200		
240		
280		
320		
360		
400		

Bench Multiplo (3 bench)

Multiple Bench desk (3 bench desks) / Banco Multiple (3 banco) / Banc Multiple (3 bancs)



L	P	H
240	160,8	75 - 75,7
300		
360		
420		
480		
540		
600		

Scrivania regolabile in altezza

Straight, height-adjustable desk / Escritorio lineal regulable en altura / Bureau linéaire réglable en hauteur



L	P	H
80	80	65 - 85
100		
120		
140		
160		
180		
200		

Piani

Tops / Tableros / Plans

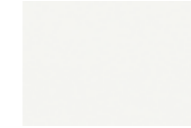

BIANCO OPACO
B17A



GRIGIO DORIAN
GL4R



ACERO
AC2J



OLMO
LM7P



OLMO STORM
OS3Q



ROVERE PORTOFINO
RP5T



ROVERE GRIGIO
RG9D

Sostegni

Support elements / Estructuras de soporte / Supports

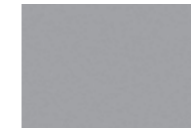

ALLUMINIO
AL5Z
(RAL 9006)

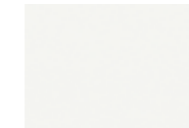

BIANCO OPACO
B17A
(RAL 9003)

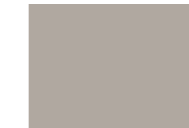

GRIGIO OXFORD
G05T



GRIGIO LONDRA
GL7H

Sostegno regolabile in altezza

Support can be adjusted for height / Soporte regulable en altura / Support réglable en hauteur

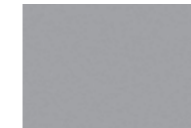

ALLUMINIO
AL5Z
(RAL 9006)

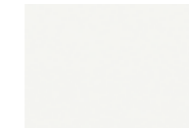

BIANCO OPACO
B17A
(RAL 9003)

LOFT - SCRIVANIE PIANI IN VETRO

LOFT - Glass desks tops / LOFT - Escritorios con tablero de cristal / LOFT - Bureaux plan en verre

Scrivanìa

Desk / Escritorio / Bureau



L	P	H
160	80	75
180		
200		

Scrivanìa per mobile di servizio, porta CPU e Swing

Desk for service unit, CPU holder and Swing element / Escritorio para mueble de servicio, porta CPU y Swing / Bureau pour meuble de service, support pour tour PC et Swing



L	P	H
160	80	75
180		
200		

Scrivanìa regolabile in altezza

Straight, height-adjustable desk / Escritorio regulable en altura / Bureau linéaire réglable en hauteur



L	P	H
160	80	65 - 85
180		
200		

Piani vetro

Glass tops / Tableros de cristal / Plans en verre



BRI
BR1L

BIANCO LATTE
WH1M

OXFORD
XF3B

LONDRA
LN6U

NERO
NE5P

Sostegni

Support elements / Pies de soporte / Supports



ALLUMINIO
AL5Z
(RAL 9006)

BIANCO OPACO
BI7A
(RAL 9003)

GRIGIO OXFORD
GO5T

GRIGIO LONDRA
GL7H

Sostegno regolabile in altezza

Support can be adjusted for height / Soporte regulable en altura / Support réglable en hauteur

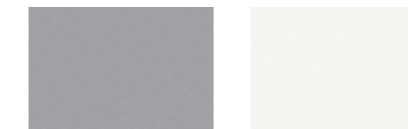

ALLUMINIO
AL5Z
(RAL 9006)

BIANCO OPACO
BI7A
(RAL 9003)

LOFT - SCHERMI

LOFT - Partitions / LOFT - Pantallas / LOFT - Panneaux

Schermo lineare per scrivania e bench

Straight partitions for desk and bench desk / Pantalla lineal para escritorio y banco / Panneau linéaire pour bureau et banc



L	P	H
60	1,8	29,7
80		
100		
120		
140		
160		
180		
200		

Schermo sagomato per scrivania e bench

Shaped partitions for desk and bench desk / Pantalla perfilada para escritorio y banco / Panneau profilé pour bureau et banc



L	P	H
80	2,5	32,2
100		
120		
140		
160		
180		

Schermo sagomato Vela per scrivania

Shaped Vela partition for desk / Pantalla perfilada Vela para escritorio / Panneau profilé Vela pour bureau



L	P	H
120	2,5	85,5

Schermo fonoassorbente per scrivania e bench

Soundproof partitions for desk and bench desk / Pantalla fonoabsorbente para escritorio y banco / Panneau acoustique absorbant pour bureau et banc



L	P	H
80	3	39
120		
160		

Schermi melaminico

Melamine partitions / Pantallas melamínicas / Panneaux mélaminés

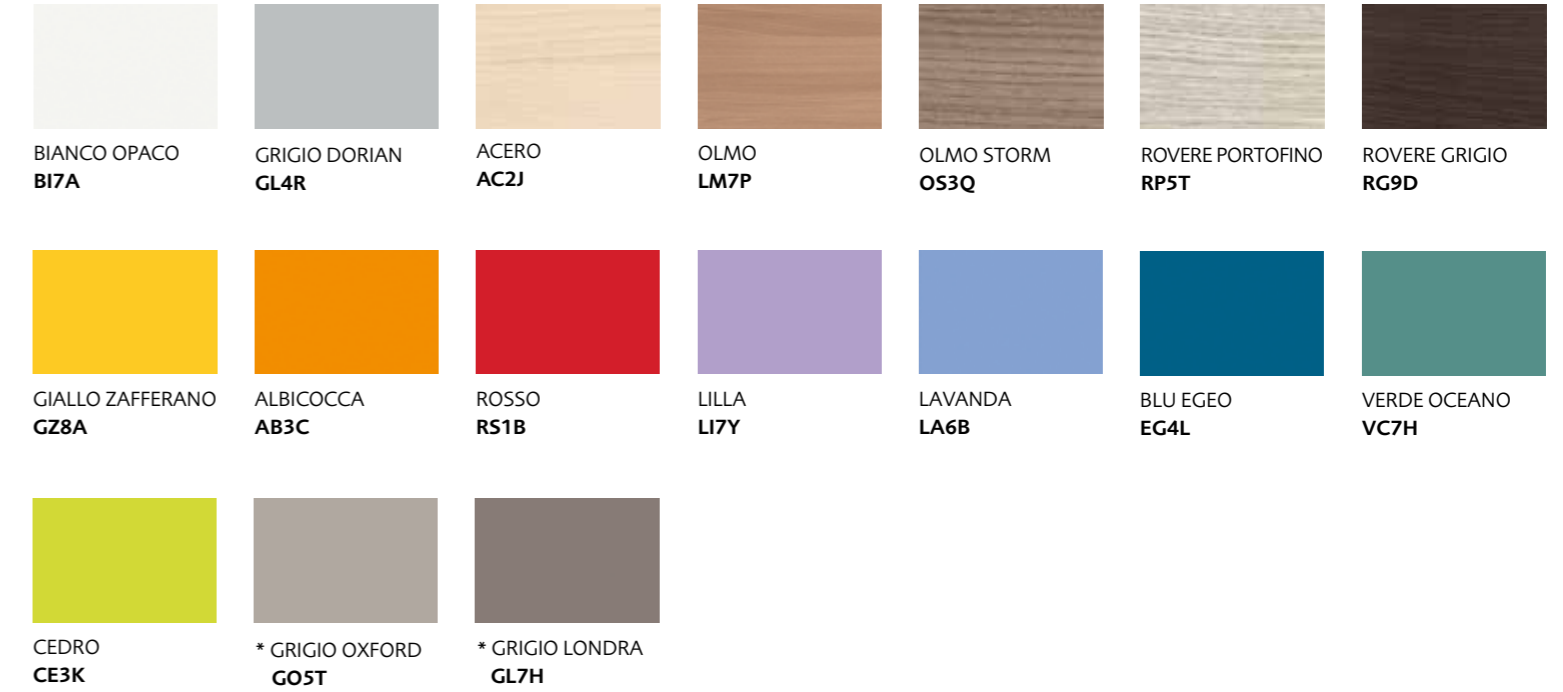

Schermi fonoassorbenti

Soundproof partitions / Pantallas fonoabsorbentes / Panneaux acoustiques absorbants



(*) Disponibili solo per schermi lineari/
Only available for straight partitions /
Disponibles solo para pantalla lineales /
Disponibles pour panneaux linéaire.

LOFT - MODESTY PANEL

LOFT - Modesty panel / LOFT - Modesty panel / LOFT - Modesty panel

Modesty panel lineare per scrivania

Straight modesty panel for desk / Modesty panel lineal para escritorio / Modesty panel linéaire pour bureau



L	P	H
60	1,8	44,7
80		
100 (*)		
120 (*)		
140 (*)		
160		
180		

(*) Disponibile anche per scrivania con cassettiera base o mobili
Also available for desk with base drawer unit or support unit
Disponible también para escritorio con cajonera base o móvil
Egalement disponible pour bureau avec caisson à tiroirs de base ou mobile

Modesty panel sagomato per scrivania

Shaped modesty panel for desk / Modesty panel perfilado para escritorio / Modesty panel profilé pour bureau



L	P	H
80	2,5	44,7
100 (*)		
120 (*)		
140 (*)		
160		
180		

(*) Disponibile anche per scrivania con cassettiera base o mobili
Also available for desk with base drawer unit or support unit
Disponible también para escritorio con cajonera base o móvil
Egalement disponible pour bureau avec caisson à tiroirs de base ou mobile

Modesty panel a terra per scrivania

Straight, full modesty panel for desk / Modesty panel en tierra para escritorio / Modesty panel linéaire au sol pour bureau



L	P	H
100 (*)	1,8	72,2
120 (*)		
140 (*)		
160		
180		

(*) Disponibile anche per scrivania con cassettiera base o mobili
Also available for desk with base drawer unit or support unit
Disponible también para escritorio con cajonera base o móvil
Egalement disponible pour bureau avec caisson à tiroirs de base ou mobile

Modesty panel lineare - Modesty panel sagomato

Straight modesty panel - Shaped modesty pane / Modesty panel lineal - Modesty panel perfilado / Modesty panel linéaire - Modesty panel profil

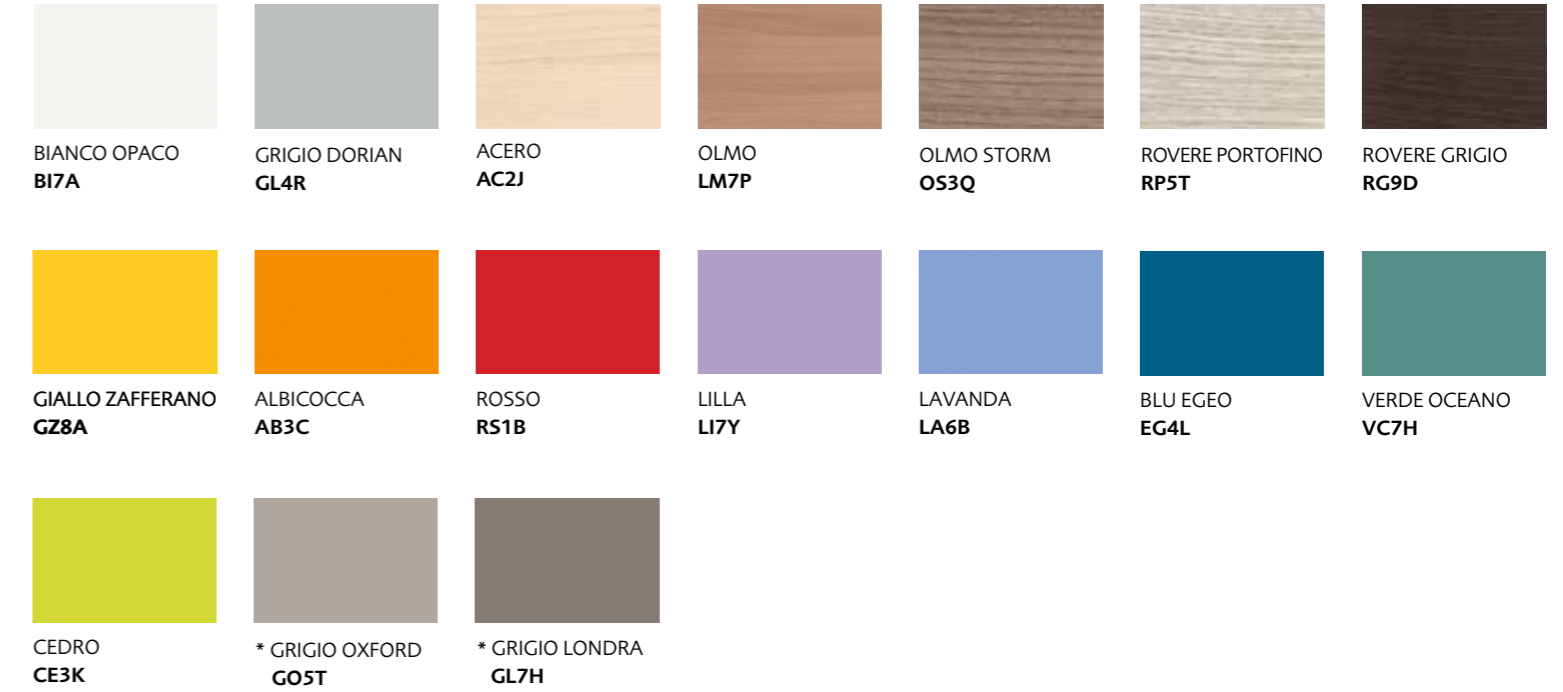

Modesty panel a terra

Full modesty panel / Modesty panel en tierra / Modesty panel au sol

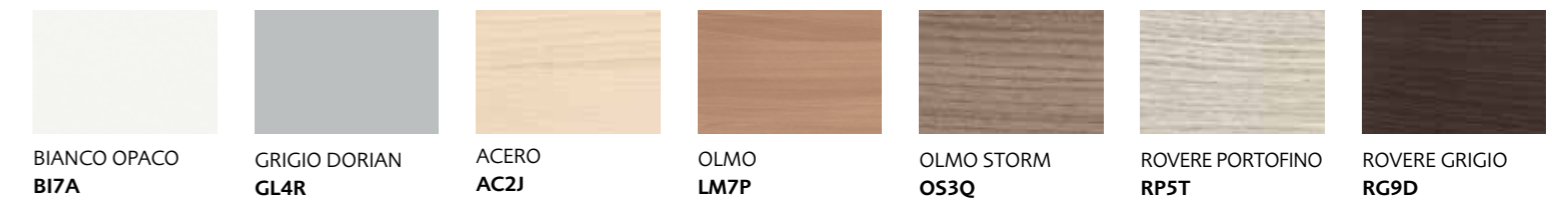

(*) Disponibili solo per modesty panel lineare /
Only available for straight modesty panel /
Disponibles solo para modesty panel lineal /
Disponibles pour modesty panel linéaire uniquement.

LOFT - MOBILE SWING

LOFT - Swing element / LOFT - Mueble Swing / LOFT - Meuble Swing



L	P	H
144	59,7	62,5

Struttura

Structure / Estructura / Structure

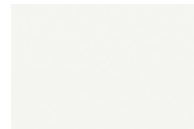

BIANCO OPACO
B17A



GRIGIO DORIAN
GL4R



ACERO
AC2J



OLMO
LM7P



OLMO STORM
OS3Q



ROVERE PORTOFINO
RP5T



ROVERE GRIGIO
RG9D



GRIGIO OXFORD
G05T



GRIGIO LONDRA
GL7H

Ante scorrevoli

Sliding doors / Puertas corredizas / Portes coulissantes

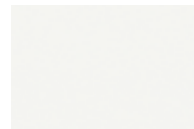

BIANCO OPACO
B17A



GRIGIO DORIAN
GL4R



ACERO
AC2J



OLMO
LM7P



OLMO STORM
OS3Q



ROVERE PORTOFINO
RP5T



ROVERE GRIGIO
RG9D



GIALLO ZAFFERANO
GZ8A



ALBICOCCA
AB3C



ROSSO
RS1B



LILLA
LI7Y



LAVANDA
LA6B



BLU EGEO
EG4L



VERDE OCEANO
VC7H



CEDRO
CE3K



GRIGIO OXFORD
G05T



GRIGIO LONDRA
GL7H

LOFT - MOBILE PORTA CPU

LOFT - CPU Stand / LOFT - Mueble porta CPU / LOFT - Meuble support pour tour PC



L	P	H
33,5	60	62,5
	80	
	100	

Struttura

Structure / Estructura / Structure

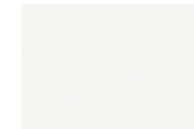

BIANCO OPACO
B17A



GRIGIO DORIAN
GL4R



ACERO
AC2J



OLMO
LM7P



OLMO STORM
OS3Q



ROVERE PORTOFINO
RP5T



ROVERE GRIGIO
RG9D



GRIGIO OXFORD
G05T



GRIGIO LONDRA
GL7H

LOFT - MOBILE DI SERVIZIO CON PIEDI

LOFT - Service modular unit with feet / LOFT - Mueble de servicio con patas / LOFT - Meuble de service avec pieds



L	P	H
90		
135	59,7	62,5
180		

Cassa

Carcase / Estructura / Structure

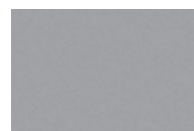

ALLUMINIO
AL1A

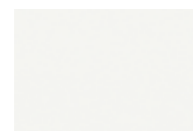

BIANCO OPACO
BI7A

Struttura, facciate e retri

Structure, fronts and backs / Structure, façades et arrières / Estructura, frentes y lados traseros

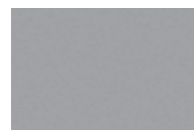

ALLUMINIO
AL1A

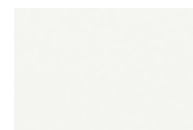

BIANCO OPACO
BI7A



GRIGIO DORIAN
GL4R



ACERO
AC2J



OLMO
LM7P



OLMO STORM
OS3Q



ROVERE PORTOFINO
RP5T



ROVERE GRIGIO
RG9D



GRIGIO OXFORD
GO5T



GRIGIO LONDRA
GL7H

LOFT - MOBILE DI SERVIZIO SU RUOTE

LOFT - Service modular unit on wheels / LOFT - Mueble de servicio con ruedas / LOFT - Meuble de service sur roulettes



L	P	H
90	59,7	63,5

Cassa

Carcase / Estructura / Structure

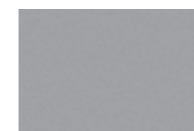

ALLUMINIO
AL1A

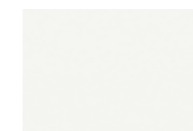

BIANCO OPACO
BI7A

Struttura e facciate

Structure and front / Estructura y frentes / Etructure et façades

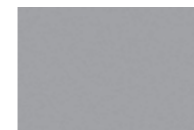

ALLUMINIO
AL1A

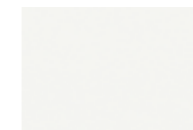

BIANCO OPACO
BI7A



GRIGIO DORIAN
GL4R



ACERO
AC2J

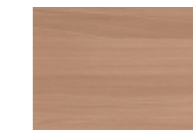

OLMO
LM7P



OLMO STORM
OS3Q



ROVERE PORTOFINO
RP5T



ROVERE GRIGIO
RG9D



GRIGIO OXFORD
GO5T



GRIGIO LONDRA
GL7H

LOFT - MOBILE BRIDGE

LOFT - Bridge elements / LOFT - Mueble Bridge / LOFT - Meuble Bridge



L	P	H
147,2	39,4	112,5
168		

Struttura

Structure / Estructura / Structure



BIANCO OPACO B17A * GRIGIO DORIAN GL4R ACERO AC2J OLMO LM7P OLMO STORM OS3Q ROVERE PORTOFINO RP5T ROVERE GRIGIO RG9D

Ante scorrevoli

Sliding doors / Puertas corredizas / Portes coulissantes



BIANCO OPACO B17A GRIGIO DORIAN GL4R ACERO AC2J OLMO LM7P OLMO STORM OS3Q ROVERE PORTOFINO RP5T ROVERE GRIGIO RG9D



GIALLO ZAFFERANO GZ8A ALBICOCCA AB3C ROSSO RS1B LILLA LI7Y LAVANDA LA6B BLU EGEO EG4L VERDE OCEANO VC7H



CEDRO CE3K GRIGIO OXFORD GO5T GRIGIO LONDRA GL7H

(*) La finitura Grigio Dorian non è disponibile per i fianchi /
The Grigio Dorian finishing is not available for the sides /
El acabado Grigio Dorian no está disponible para los laterales /
La finition Grigio Dorian n'est pas disponible pour les joues.

LOFT - MOBILE SIDE

LOFT - Side element / LOFT - Mueble Side / LOFT - Meuble Side



L	P	H
44,7	160,8	75

Struttura

Structure / Estructura / Structure



BIANCO OPACO B17A GRIGIO DORIAN GL4R ACERO AC2J OLMO LM7P OLMO STORM OS3Q ROVERE PORTOFINO RP5T ROVERE GRIGIO RG9D



GRIGIO OXFORD GO5T GRIGIO LONDRA GL7H

Ante scorrevoli

Sliding doors / Puertas corredizas / Portes coulissantes



BIANCO OPACO B17A GRIGIO DORIAN GL4R ACERO AC2J OLMO LM7P OLMO STORM OS3Q ROVERE PORTOFINO RP5T ROVERE GRIGIO RG9D



GIALLO ZAFFERANO GZ8A ALBICOCCA AB3C ROSSO RS1B LILLA LI7Y LAVANDA LA6B BLU EGEO EG4L VERDE OCEANO VC7H



CEDRO CE3K GRIGIO OXFORD GO5T GRIGIO LONDRA GL7H

LOFT - TAVOLI RIUNIONE

LOFT - Conference tables / LOFT - Mesas de reunion / LOFT - Tables de reunion

Tavolo riunione

Conference table / Mesa de reunión /
Table de réunion



L	P	H
240	120	75

Tavolo riunione componibile

Modular conference table / Table de réunion
modulable / Mesa de reunión modular



L	P	H
120	120	75

Piani

Tops / Tableros / Plans

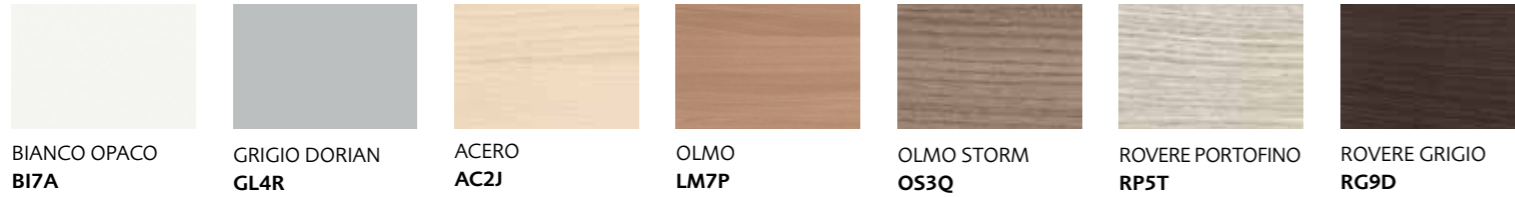

Sostegni

Support elements / Estructuras de soporte / Supports



CASSETTIERE

Chest of drawers / Muebles de sustentación / Meubles de soutènement



L	P	H
41,8	54,6	53,8

L	P	H
41,8	54,6	59,6

Cassettiere

Bearing units / Muebles de sustentación / Meubles de soutènement

Cassa

Carcase / Estructura / Structure



Top e frontali

Top and front parts / Paneles superiores y frontales / Top et façades

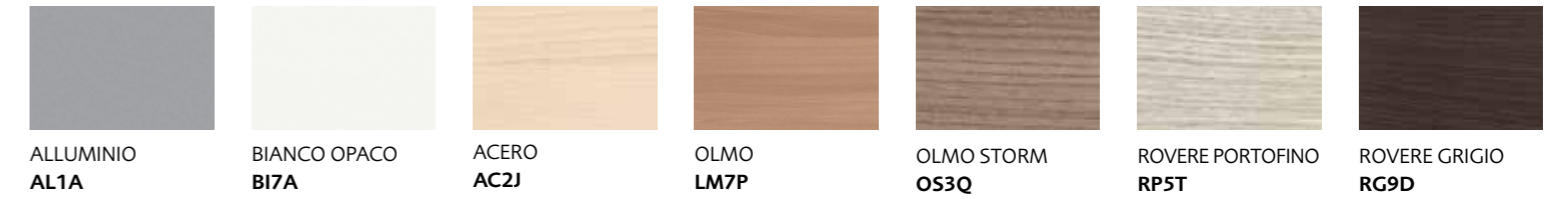

Cassettiere integrali

Whole drawer units / Cajoneras integrales / Tiroirs internes intégraux

Cassa, top e frontali

Carcase, top and front parts / Estructura, paneles superiores y frontales / Structure, top et façades

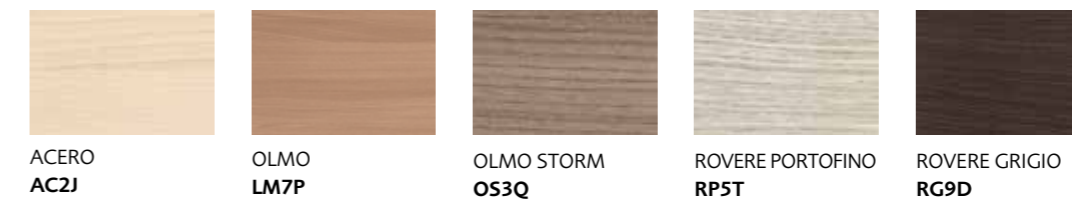

CASSETTIERE BASE

Base drawer units / Cajoneras básicas / Blocs-tiroirs bases



L	P	H
41,8	56,4	73,2
	79,6	

(*) Non disponibile per la P 79,6
Not available for 79.6 depth
No disponible para la P 79,6
Non disponible pour la P 79,6

Cassa e frontali

Carcase and front parts / Estructura y frontales / Structure et façades



ALLUMINIO AL1A BIANCO OPACO BI7A ACERO AC2J OLMO LM7P OLMO STORM OS3Q ROVERE PORTOFINO RP5T ROVERE GRIGIO RG9D

Top in melaminico

Melamine tops / Encimeras de melamina / Plateau en mélaminé



BIANCO OPACO BI7A GRIGIO DORIAN GL4R ACERO AC2J OLMO LM7P OLMO STORM OS3Q ROVERE PORTOFINO RP5T ROVERE GRIGIO RG9D

MANIGLIE

Handles / Tiradores / Poignées



SNIP



SEL



LIG



ROD



RAN



CUT

ACCESSORI

Accessories / Accesorios / Accessoires



Top access
Access top
Top access
Top access



L	P	H
26,4	12,4	5,2



Colonna elettrificata
Electrified unit
Piètement électrique
Columna electrificada



Binario elettrificato e adattatori
Electrified rail and adapters
Rail électrifié et adaptateurs
Guía electrificada y adaptadores



L	P	H
43,5	7,5	3,5



Passacavo accessorato
Cable ducting system with accessories
Chemin de câble équipé
Pasacables con accesorios

LIBRERIA 2SIDE

2Sided bookshelf / librería 2Side / bibliothèque 2Side

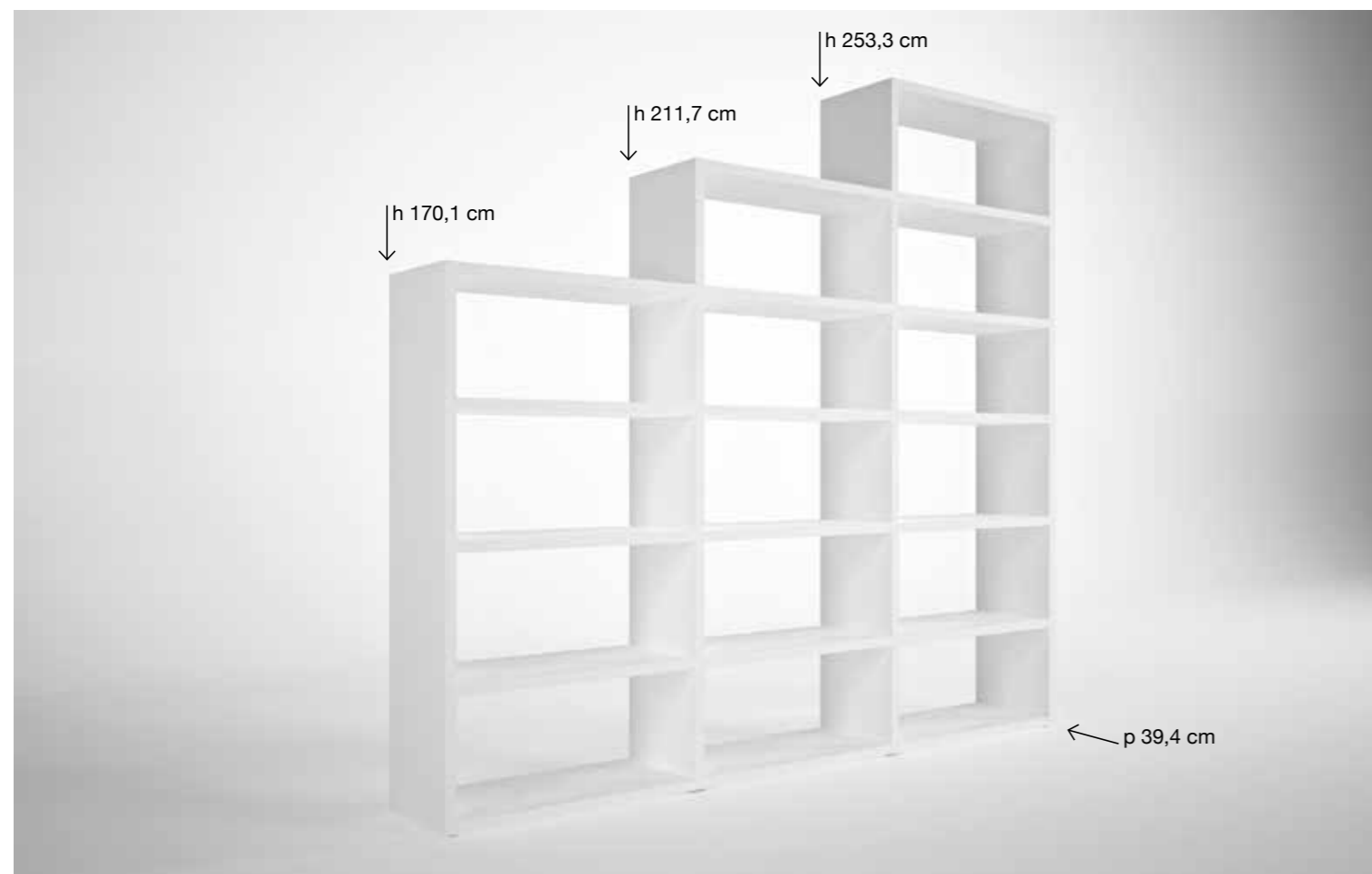

ARMADI CON ANTA LIBRO

Unit with folding door / Armarios con puerta "libro" / Armoires avec portes accordéon

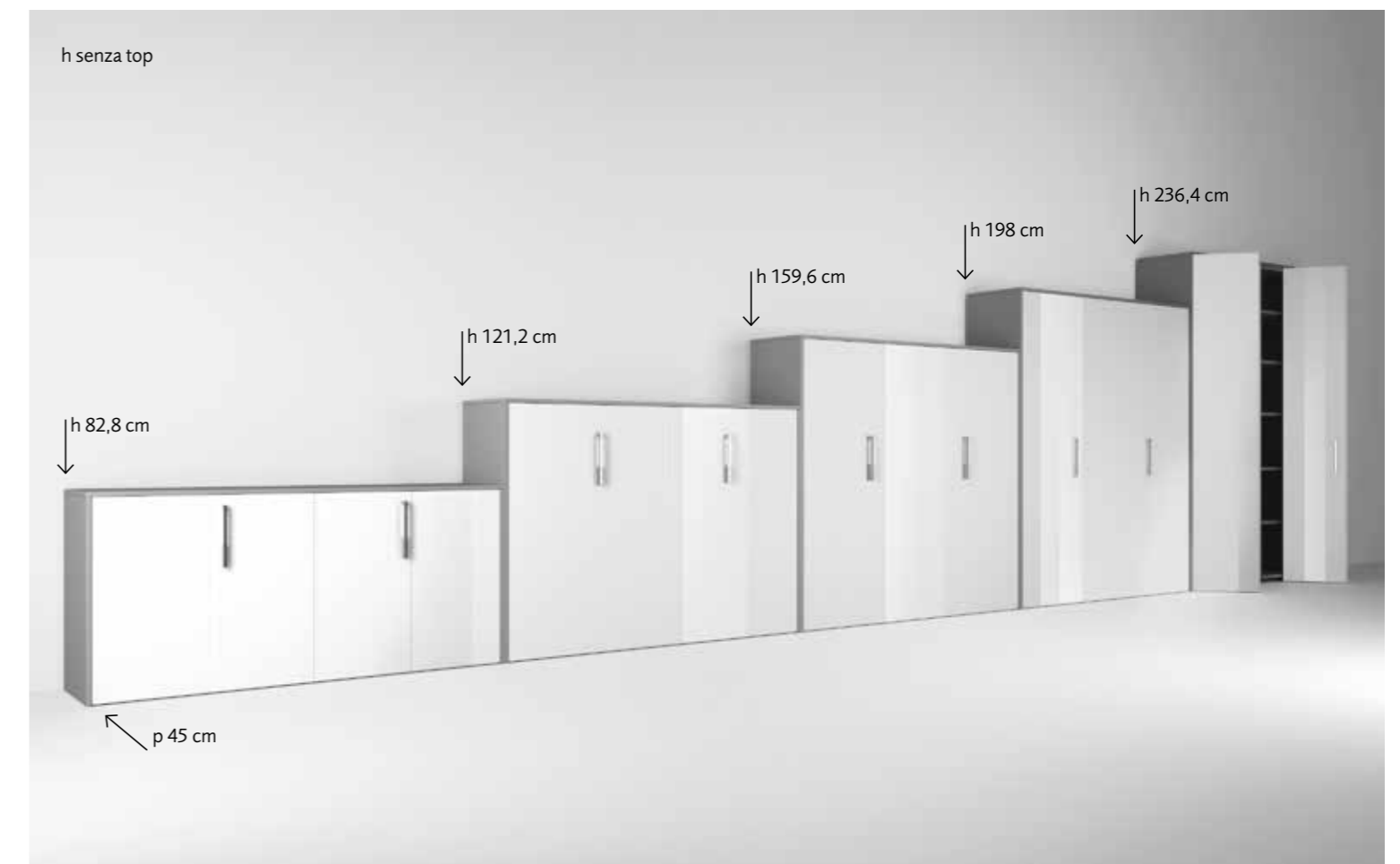

ARMADI CON ANTA BATTENTE

Hinged door wardrobes / Armarios de puerta batiente / Armoires porte a battant

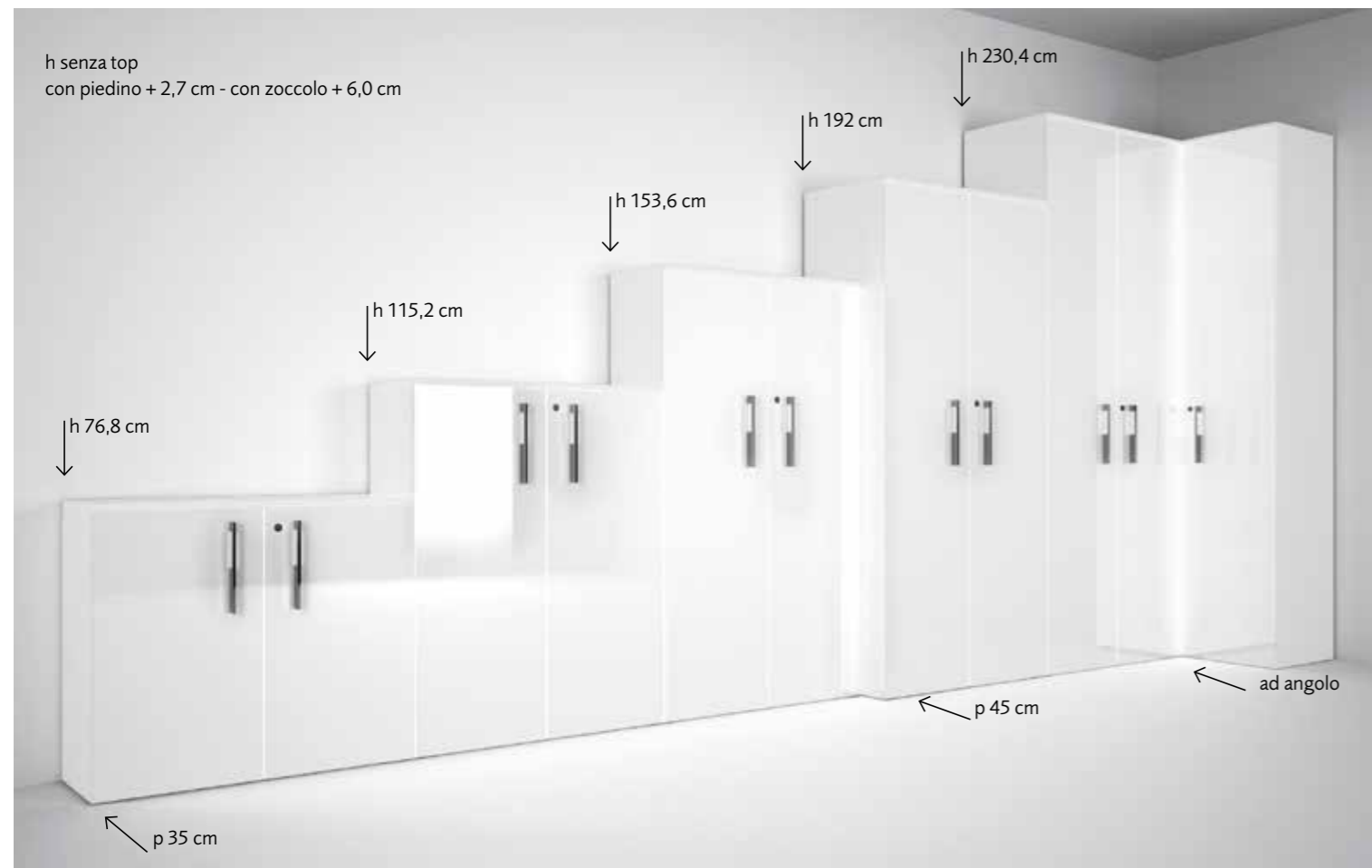

ARMADI CON ANTA SCORREVOLE

Sliding door wardrobes / Armarios de puerta corredera / Armoires porte coulissante

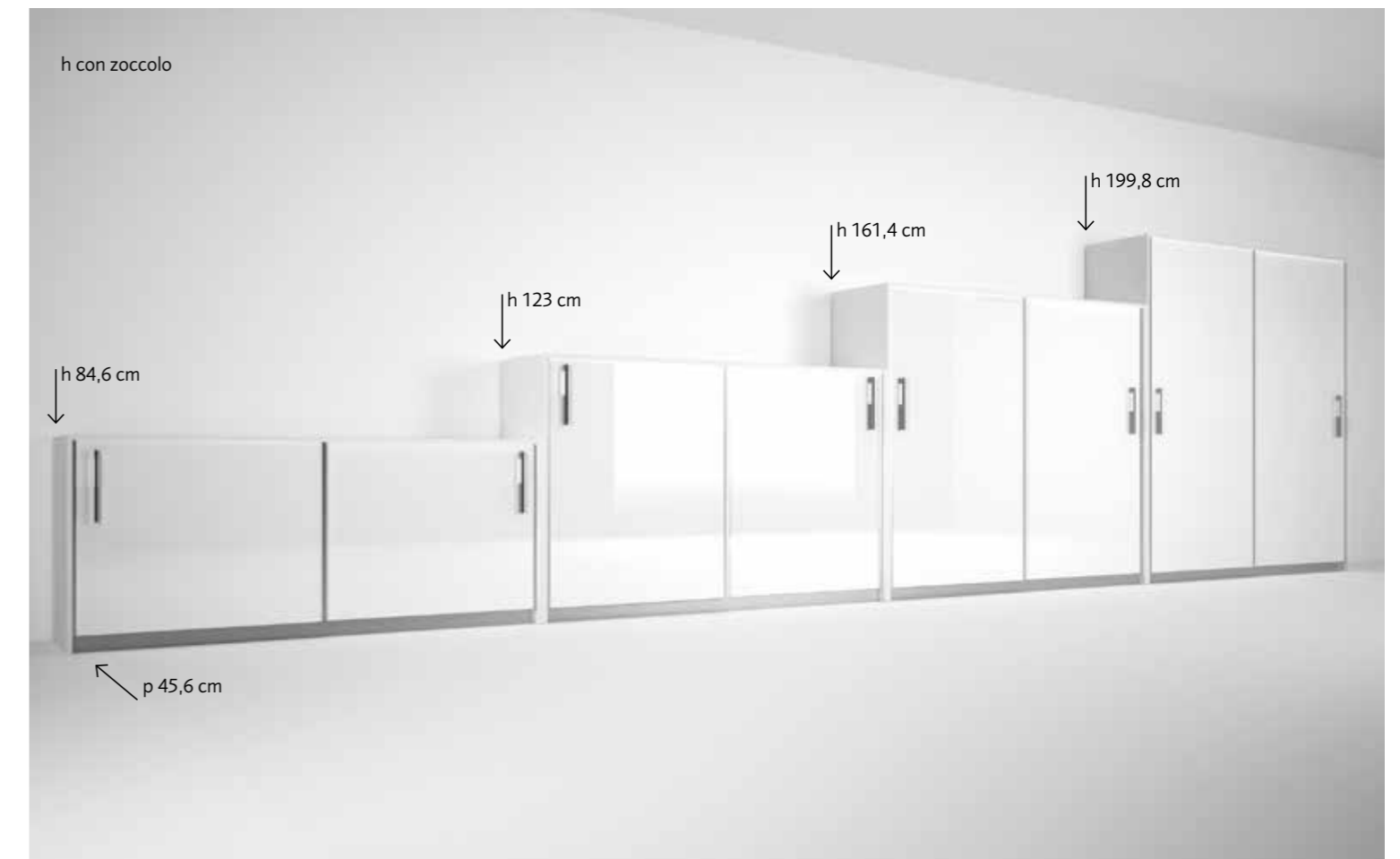

ANTA BATTENTE IN PANNELLO - ANTA 30/60

hinged panel door - door 30/60 / puertas batientes de panel - puerta 30/60 / portes battantes en panneau - porte 30/60



L	P	H				
		45	90	(*) 180	(*) 270	
45	45	76,8	115,2	153,6	192	230,4
90						
(*) 180						
(*) 270						
45	35	76,8	115,2	153,6	192	230,4
90						
(*) 180						
(*) 270						

(*) Cassa disponibile solo in alluminio.
 Non disponibili ante 30-60 /
 Structure available only in aluminium,
 Doors 30-60 not available;
 Estructura disponible sólo de aluminio.
 Puertas 30-60-no disponible.
 Structure disponible uniquement en aluminium.
 Porte 30-60 non disponible.

Cassa Carcase / Estructura / Structure

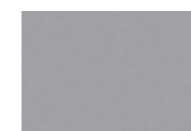

ALLUMINIO
AL1A

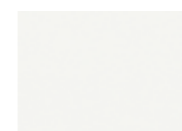

BIANCO OPACO
BI7A



ACERO
AC2J



OLMO
LM7P



ROVERE PORTOFINO
RP5T

Ante opache Matt doors / Puertas opacas / Portes mates

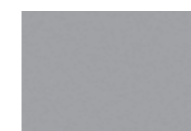

ALLUMINIO
AL1A

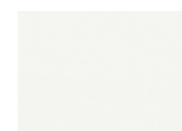

BIANCO OPACO
BI7A



GRIGIO DORIAN
GL4R



ACERO
AC2J

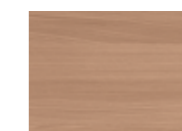

OLMO
LM7P

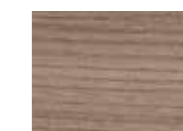

OLMO STORM
OS3Q



ROVERE PORTOFINO
RP5T



ROVERE GRIGIO
RG9D



GRIGIO OXFORD
GOST



GRIGIO LONDRA
GL7H

Ante lucide Glossy doors / Puertas brillantes / Portes brillantes

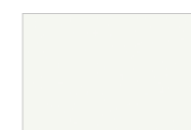

BIANCO LUX
BX3J

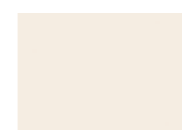

AVORIO LUX
AX1K



VISIONE LUX
VL4C



NERO LUX
NX5Y

ANTA BATTENTE IN VETRO TRASPARENTE

Transparent glass hinged door / Puerta batiente de vidrio transparente / porte battante en verre transparent



L	P	H			
45	45	76,8	115,2	153,6	192
90					
(*) 180					
(*) 270					
45	35	76,8	115,2	153,6	192
90					
(*) 180					
(*) 270					

(*) Cassa disponibile solo in alluminio /
Casing available only in aluminium /
Caja disponible sólo en aluminio /
Caisse disponible uniquement en aluminium

Cassa
Carcase / Estructura / Structure



ALLUMINIO AL1A BIANCO OPACO BI7A ACERO AC2J OLMO LM7P ROVERE PORTOFINO RP5T

Anta
Doors / Puertas / Portes

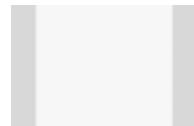

TRASPARENTE TR9M

ANTA BATTENTE IN VETRO CON TELAIO IN ALLUMINIO

Glass hinged door with aluminium frame / Puerta batiente de cristal / Porte battante en verre



L	P	H			
45	45	76,8	115,2	153,6	192
90					
(*) 180					
(*) 270					
45	35	76,8	115,2	153,6	192
90					
(*) 180					
(*) 270					

(*) Cassa disponibile solo in alluminio /
Casing available only in aluminium /
Caja disponible sólo en aluminio /
Caisse disponible uniquement en aluminium

Cassa
Carcase / Estructura / Structure



ALLUMINIO AL1A BIANCO OPACO BI7A ACERO AC2J OLMO LM7P ROVERE PORTOFINO RP5T

Anta
Doors / Puertas / Portes



BRI BR1L BIANCO LATTE WH1M RED RE4L NERO NE5P

ANTA LIBRO

Folding door / Puerta ap. "de libro" / Porte accordéon



L	P	H				
(*) 180	45	82,8	121,2	159,6	198	236,4

(*) Cassa disponibile solo in alluminio /
Casing available only in aluminium /
Caja disponible sólo en aluminio /
Caisse disponible uniquement en aluminium



Cassa
Carcase / Estructura / Structure

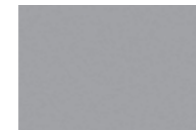

ALLUMINIO
AL1A

Ante opache

Matt doors / Puertas opacas / Portes mates



ALLUMINIO AL1A BIANCO OPACO B17A GRIGIO DORIAN GL4R ACERO AC2J OLMO LM7P OLMO STORM OS3Q ROVERE PORTOFINO RP5T



ROVERE GRIGIO RG9D GRIGIO OXFORD GO5T GRIGIO LONDRA GL7H

Ante lucide

Glossy doors / Puertas brillantes / Portes brillantes



BIANCO LUX BX3J AVORIO LUX AX1K VISIONE LUX VL4C NERO LUX NX5Y

ANTA SCORREVOLE IN PANNELLO

Panel sliding door / Puerta corredera en el panel / Porte coulissante en panneau



L	P	H			
182,5	45,6	84,6	123	161,4	199,8
271,3					



Cassa
Carcase / Estructura / Structure

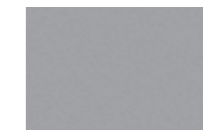

ALLUMINIO
AL1A

Ante opache

Matt doors / Puertas opacas / Portes mates



ALLUMINIO AL1A BIANCO OPACO B17A GRIGIO DORIAN GL4R ACERO AC2J OLMO LM7P OLMO STORM OS3Q ROVERE PORTOFINO RP5T



ROVERE GRIGIO RG9D

Ante lucide

Glossy doors / Puertas brillantes / Portes brillantes



BIANCO LUX BX3J AVORIO LUX AX1K VISIONE LUX VL4C NERO LUX NX5Y

ANTA SCORREVOLE CON INSERTO

Sliding door with insert / Puerta corredera con inserto / Porte coulissante avec élément



L	P	H	
182,5	45,6	161,4	199,8
271,3			

Alcuni esempi di composizione
Suggested compositions
Ejemplos de composición
Exemples de composition



Cassa
Carcase / Estructura / Structure



ALLUMINIO
AL1A

Inserto lucido
Glossy insert / Detalle brillante / Bande brillante



BIANCO LUX
BX3J

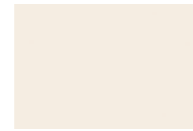

AVORIO LUX
AX1K



VISONE LUX
VL4C



NERO LUX
NX5Y

Inserto opaco
Matt insert / Detalle opaco / Bande opaque

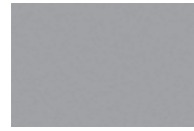

ALLUMINIO
AL1A

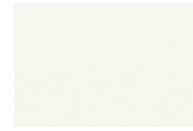

BIANCO OPACO
BI7A



GRIGIO DORIAN
GL4R



ACERO
AC2J



OLMO
LM7P



OLMO STORM
OS3Q



ROVERE PORTOFINO
RP5T



ROVERE GRIGIO
RG9D

ANTA SCORREVOLE IN VETRO CON TELAIO IN ALLUMINIO

Glass sliding door with aluminium frame / Puerta corredera de cristal con estructura de aluminio / Porte coulissante en verre avec cadre en aluminium



L	P	H		
182,5	45,6	84,6	123	161,4
271,3				199,8

Cassa
Carcase / Estructura / Structure

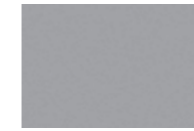

ALLUMINIO
AL1A

Anta
Doors / Puertas / Portes



BRI
BR1L

BASI PER ARMADIO

Base units for wardrobe / Bases para armario / Bases pour armoire



L	P	H
169,8	47,9	6,5
214,8		
259,8		

Basi per armadi P45
Base units for wardrobe P45
Bases para armario P45
Bases pour armoire P45

L	P	H
169,8	37,9	6,5
214,8		
259,8		

Basi per armadi P35
Base units for wardrobe P35
Bases para armario P35
Bases pour armoire P35



ACERO
AC2J



OLMO
LM7P



OLMO STORM
OS3Q



ROVERE PORTOFINO
RP5T

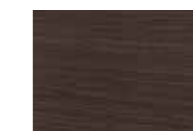

ROVERE GRIGIO
RG9D

KIT DI FINITURA

Finishing kit / Kit de revestimiento / Kit de revêtement



L	P	H				
(*) 45	45,6	76,8	115,2	(*)153,6	(*) 192	(*) 230,4
(*) 90						
(*) 135						
(*) 180						
(*) 225						
270						
(*) 45	35,6	76,8	115,2	(*)153,6	(*) 192	(*) 230,4
(*) 90						
(*) 135						
(*) 180						
(*) 225						
270						

(*) Lunghezze e altezze disponibili per kit lucidi, Grigio Oxford e Grigio Londra.
Lengths and heights available for glossy kits, Grigio Oxford and Grigio Londra.
Largos y alturas disponibles para kit brillantes, Grigio Oxford y Grigio Londra.
Longueurs et hauteurs disponibles pour kits brillants, Grigio Oxford et Grigio Londra.

Top e fianchi di finitura opachi

Top and matt finishing side panels / Encimera y costados de terminación opacos / Plateau et joues latérales opaques

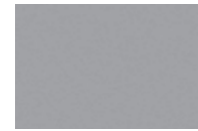

ALLUMINIO
AL1A



BIANCO OPACO
B17A



ACERO
AC2J



OLMO
LM7P



OLMO STORM
OS3Q



ROVERE PORTOFINO
RP5T



ROVERE GRIGIO
RG9D



GRIGIO OXFORD
GOST



GRIGIO LONDRA
GL7H

Top e fianchi di finitura lucidi

Top and glossy finishing side panels / Encimera y costados de terminación brillantes / Plateau et joues latérales brillants



BIANCO LUX
BX3J

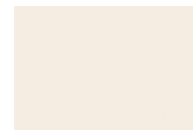

AVORIO LUX
AX1K



VISONE LUX
VL4C



NERO LUX
NX5Y

LIBRERIA MILTON

Milton bookcase / Estantería milton / Bibliotheque milton



L	P	H
77,5	30,7	78
115,3	30,7	115,8

Cassa

Carcase / Estructura / Structure

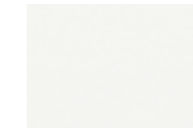

BIANCO OPACO
B17A

MONOBLOCCO

Single unit / Monobloque / Monobloc



L	P	H
155	60	223,2
185		

Cassa

Carcase / Estructura / Structure

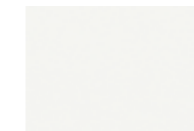

BIANCO OPACO
B17A

Ante opache

Matt doors / Puertas opacas / Portes mates

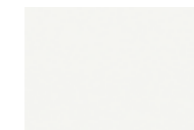

BIANCO OPACO
B17A



OLMO
LM7P



OLMO STORM
OS3Q

Maniglia monoblocco

Single-casting handle / Tirador monobloque / Poignée monobloc

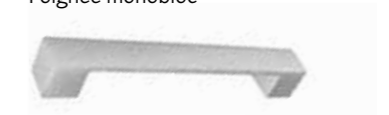

CLICK